



Owner's Manual

UltraScan™ Table

Owner _____

Model _____

Serial # _____

Date _____

Table of Contents

Table of Contents	2
Symbols and Definitions	4
Precautions	5
Intended Use	8
Set Up	8
Safety Features	9
Operation	10
Hand-Wand.....	11
Individual Locking Casters	12
Single Pedal Brake (optional).....	13
Drop Sections (on select models)	14
Back Rest (on select models).....	16
Non-Pinch Closure (on select models).....	17
Manually Operated/Removable Foot-Drop Section	18
Foot Board (on select models)	19
Foot Stirrups	20
Removable Collection Tray (on select models)	20
Accessories	21
Safety Rails.....	21
Sonographer's Extension	23
Padded Arm Board	24
Carotid Head Rest	25
IV Pole Holder	26
Patient Positioning Safe-T-Wedges™	26
Preventative Maintenance	27
Cleaning.....	28
Troubleshooting Guide	30
UltraScan™ Table Parts List	32
Specifications and Warranty	34
Specifications	34
Warranty	36

MEDICAL POSITIONING, INC
 1717 Washington Street
 Kansas City, MO 64108

UltraScan™ Table

Attribute	Rating (120V Version)	Rating (230V Version)
Voltage	120 VAC	230 VAC
Amperage	2 A	1 A
Cycle	50/60 Hz	50/60 Hz
Duty Cycle	10%, 1 min. on/10 min. off	10%, 1 min. on/10 min. off
Leakage Current	< 100 µA	< 100 µA
Maximum Distributed Load	500 lbs.	500 lbs.

UL 60601-1 CLASSIFICATIONS:

- Class 1 Equipment
- Type B Applied Part
- Degree of Protection Against Ingress of Water / IPX0
- Equipment Not Suitable for Use in Flammable Anesthetic Mixture

All electrical circuitry is isolated from chassis.
 Grounding reliability can only be achieved when the equipment is connected to an equivalent receptacle marked “Hospital Only” or “Hospital Grade”
 The power cord is to be used for mains disconnection.



MEDICAL EQUIPMENT WITH RESPECT TO ELECTRICAL SHOCK, FIRE AND MECHANICAL HAZARDS ONLY IN ACCORDANCE WITH UL 60601-1 AND CAN/CSA C22.2 NO. 601.1

Environment Operating Range

Temperature range within +5 to +40 C
 Relative humidity range within 15% to 95%
 Atmospheric pressure range within 700 to 1060 hPa

Transportation and storage:

Temperature range within -40 to 70 C
 Relative humidity range within 10% to 100%
 Atmospheric pressure range within 500 to 1080 hPa

Symbols and Definitions



Blue circle with white figure holding book

Warning, follow instructions for use. Failure to comply may result in injury.



Red circle with line through it with black figure in background

Warning, stepping is prohibited. Failure to comply may result in injury.



Type B Applied Part

Applied Part complying with specified requirements for protection against electric shock. Type B Applied Parts are those parts, which are usually Earth referenced. Type B are those parts not suitable for direct cardiac application



Attention

Attention, consult accompanying documents



Protective Earth

Any terminal which is intended for connection to an external protective conductor for protection against electric shock in case of a fault



This device contains materials that are potentially hazardous to the environment. In accordance with the DIRECTIVE 2002/96/EC OF THE EUROPEAN PARLIAMENT AND OF THE CONCIL on waste electrical and electronic equipment (WEEE), the UltraScan™ electrical system and accessories should not be disposed as unsorted municipal waste. Consult your instructional policies and local regulations regarding disposal. Contact your Medical Positioning, Inc. Service Representative if additional disposal details are required.

Precautions

Your UltraScan™ Table has been pre-assembled and tested to ensure operation on day one. Please closely inspect it when you receive it to ensure no damage has occurred during shipment. Because it is a complex piece of equipment, make note of the following precautions.



Figure 1

- ⚠ **WARNING, POTENTIAL FOR INJURY OR DEATH.** Do not leave patient unattended while using the table.
- ⚠ **WARNING, POTENTIAL FOR INJURY OR DEATH.** Do not modify this equipment without authorization of the manufacturer.
- ⚠ **WARNING, POTENTIAL FOR INJURY OR DEATH.** Do not use in oxygen rich environment.
- ⚠ **WARNING, POTENTIAL FOR INJURY OR DEATH.** The foot drop section is designed to support more weight than a patient's legs alone, but it is a collapsible and/or removable section and is not designed to support full patient body weight. Never allow the patient to apply full body weight to the extended foot drop section portion of the table while entering or exiting the table as this may result in instability of the table. Have the patient enter and exit the table from the side or from the foot end with the foot section collapsed.
- ⚠ **WARNING, POTENTIAL FOR INJURY OR DEATH.** To reduce the risk of electrical shock, grounding reliability can only be achieved when the equipment is connected to an equivalent receptacle marked "hospital only" or "hospital grade".
- ⚠ **WARNING, POTENTIAL FOR INJURY OR DEATH.** To reduce the risk of electrical shock, do not remove secured covers. Refer servicing to qualified personnel.
- ⚠ **WARNING, POTENTIAL FOR INJURY OR DEATH.** To reduce the risk of a potential fall, lock all casters before using equipment.
- ⚠ **WARNING, POTENTIAL FOR INJURY OR DEATH.** Once the table and patient have been properly positioned, ensure the casters are locked and the hand wand is placed in a safe position to prevent incidental contact and unwanted movement of the table surface during the procedure.

- ⚠ **WARNING, POTENTIAL FOR INJURY.** To reduce the risk of a potential fall, do not use the product to transport patient between rooms or over thresholds.
- ⚠ **WARNING, POTENTIAL FOR INJURY.** Avoid placing your hand in or near the drop section mechanism during operation
- ⚠ **WARNING, POTENTIAL FOR INJURY OR DEATH.** After closing, always lift up on the drop section to assure that is totally locked before patient entry or exit.
- ⚠ **WARNING, POTENTIAL FOR INJURY.** Failure to hold the back rest when the lever release lever will result in the back rest lowering suddenly, possibly causing injury to the patient.
- ⚠ **WARNING, POTENTIAL FOR INJURY.** Do not operate drop section or back rest if non-pinch closure flap is absent. The flap is attached to the bed with hook and loop tape and can easily be adjusted whenever necessary.
- ⚠ **WARNING, POTENTIAL FOR INJURY OR DEATH.** Verify both sides of the foot drop section's hinges have the pivot locks engaged when raising the foot section. Failure to have both pivot locks engaged can result in sudden lowering of the foot drop section.
- ⚠ **WARNING, POTENTIAL FOR INJURY.** Keep hands clear of the foot section hinges during operation.
- ⚠ **WARNING POTENTIAL FOR INJURY.** Periodically check both sides of the foot drop section's hinges to make sure they are between the receivers mounted on both sides of the table's frame.
- ⚠ **WARNING, POTENTIAL FOR INJURY.** Use care to firmly hold the removed foot drop section. Failure to hold the foot drop section could result in dropping the foot drop section.
- ⚠ **WARNING, POTENTIAL FOR INJURY OR DEATH.** Always raise the foot board when in reverse Trendelenburg (foot end down) positions greater than 15°. Failure to raise the foot board may result in the patient sliding off the table surface.
- ⚠ **WARNING, POTENTIAL FOR INJURY OR DEATH.** The foot board is designed to support more weight than a patient's legs alone, but it is a collapsible a section and is not designed to support full patient body weight. Never allow the patient to apply full body weight to the extended foot board while entering or exiting the table as this may result in instability of the table. Have the patient enter and exit the table from the side or from the foot end with the foot section collapsed.
- ⚠ **WARNING, POTENTIAL FOR INJURY.** Keep hands clear of the foot board hinges during operation.
- ⚠ **WARNING, POTENTIAL FOR INJURY.** The foot board is collapsible and thus care should be taken when lowering the foot board to avoid closing on the patient's feet and/or legs.
- ⚠ **WARNING, POTENTIAL FOR INJURY OR DEATH.** The foot stirrup is designed to support more weight than a patient's legs alone, yet is not

designed to support full patient body weight. Never allow the patient to apply full body weight to the foot stirrup.

- ⚠ **WARNING, POTENTIAL FOR INJURY OR DEATH.** Always verify the safety rail is securely latched in the up position before using the table with the safety rail raised. Failure to have the safety rail latched in the raised position may result in a patient fall.
- ⚠ **WARNING, POTENTIAL FOR INJURY.** Securely tighten the Hand Wheel for the padded arm board prior to performing any procedures utilizing the padded arm board.
- ⚠ **WARNING, POTENTIAL FOR INJURY.** Securely tighten the adjustment knobs for the carotid head rest prior to performing any procedures utilizing the carotid head rest.
- ⚠ **CAUTION, PRODUCT DAMAGE MAY RESULT.** Secure hand wand with hook and loop fastener when not in use. Keep cable clear of moving parts.
- ⚠ **CAUTION, PRODUCT DAMAGE MAY RESULT.** It is not necessary to "slam" the arm board closed. Slamming the arm board closed will startle the patient and may result in damage to the mechanism.
- ⚠ **CAUTION, PRODUCT DAMAGE MAY RESULT.** Protect vinyl upholstery from sharp objects and abrasion to avoid damage.
- ⚠ **CAUTION, PRODUCT DAMAGE MAY RESULT.** Refer to instructions located in this manual for vinyl cleaning recommendations.
- ⚠ **CAUTION, PRODUCT DAMAGE MAY RESULT.** Do not use abrasives to clean painted surfaces.

Intended Use

The product is intended for use with general ultrasound systems. The product is intended for the environment where ultrasound systems are used, including hospitals, outpatient facilities, and doctor’s offices. The product is contraindicated for patients that cannot safely sit in a chair or lie on an elevated surface.

- ⚠ **WARNING, POTENTIAL FOR INJURY OR DEATH. Do not leave patient unattended while using the table.**
- ⚠ **WARNING, POTENTIAL FOR INJURY OR DEATH. Do not modify this equipment without authorization of the manufacturer.**
- ⚠ **WARNING, POTENTIAL FOR INJURY OR DEATH. Do not use in oxygen rich environment.**

Set Up

Your UltraScan™ Table has been shipped to you in “plug and play” condition. After unpacking the product, we recommend performing an initial test of your UltraScan™ Table to ensure that each function is in correct working order. After reviewing this manual you are ready to begin using your UltraScan™ Table.

System Test Procedure

The hand-wand is a low voltage, DC operated device. The cable begins at the hand wand and plugs into the control box.

- ⚠ **WARNING, POTENTIAL FOR INJURY OR DEATH. To reduce the risk of electrical shock, grounding reliability can only be achieved when the equipment is connected to an equivalent receptacle marked “hospital only” or “hospital grade”.**

STEP	ACTION
1	After removing padding and packaging materials, locate primary power supply cord and attach to suitable grounded outlet.
2	To test actuator function, locate the hand-wand and depress each function button one at a time. (Depressing multiple buttons simultaneously will prevent the motor from operating.) Figure 2.
3	If any function does not operate, perform the test procedures listed in the Troubleshooting Guide

Isolation from the external electrical supply can be obtained by unplugging the power cord from the wall outlet or by unplugging the power cord from the control box.

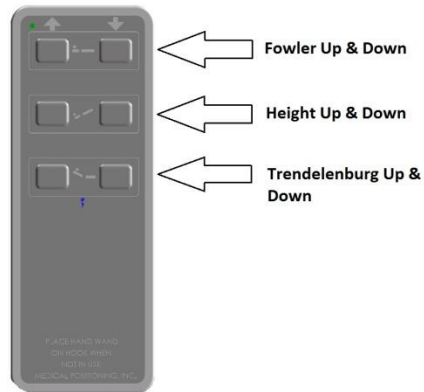

Figure 2

Only select models have Trendelenburg functionality.

Safety Features

- This product is equipped with multiple automated safety features to prevent danger or damage during use. The entire system is electrically isolated to UL/IEC 60601-1 and CAN/CSA C22.2 No. 601.1 hospital safety standards
- The actuator assemblies are current overload protected. If overloaded, the actuators will stop and reset automatically.
- The sealed hand-wand operates the actuators by directing small amounts of low voltage D.C. current to the control box. All of the actuator drives are equipped with internal limit switches which automatically prevent over-extension.
- The tables are equipped with total locking, sealed bearing, and braking casters at all four corners.

Operation

Your UltraScan™ Table is shipped assembled and ready for use. Each function has been pre-tested to ensure perfect working order on day one.

A “**Troubleshooting Guide**” is included in this manual to assist you in the event of a malfunction.

Functionality in this section

- Hand-wand
- Individual Locking Casters
- Single Pedal Brake (optional)
- Drop Sections (on select models)
- Back Rest (on select models)
- Non-Pinch Flap (on select models)
- Manually Operated/Removable Foot-Drop Section
- Foot Board (on select models)
- Foot Stirrups
- Removable Collection Tray (on select models)

Hand-Wand

The hand wand is a low voltage device. The cable begins at the hand wand and plugs into the control box on the other end. Select models offer Trendelenburg functionality.

⚠ WARNING, POTENTIAL FOR INJURY OR DEATH. Once the table and patient have been properly positioned, ensure the casters are locked and the hand wand is placed in a safe position to prevent incidental contact and unwanted movement of the table surface during the procedure.

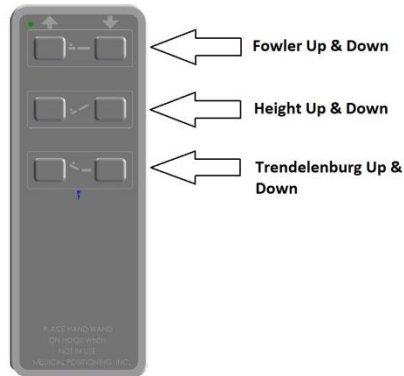

Figure 3

Only select models have Trendelenburg functionality.

The hand-wand has a hook strip on the back and the table has a loop strip on the side. Additional hook and loop strips can be used to place the hand-wand in the most convenient place for the end user.

⚠ CAUTION, PRODUCT DAMAGE MAY RESULT. Secure hand wand with hook and loop fastener when not in use. Keep cable clear of moving parts.

Individual Locking Casters

The standard casters installed on your UltraScan™ Table are total locking casters. When in the locked position, the caster is prevented from both rolling and swiveling.

- ⚠ **WARNING, POTENTIAL FOR INJURY OR DEATH.** To reduce the risk of a potential fall, lock all casters before using equipment.
- ⚠ **WARNING, POTENTIAL FOR INJURY OR DEATH.** Once the table and patient have been properly positioned for compression, ensure the casters are locked and the Hand Wand is placed in a safe position to prevent incidental contact and unwanted movement of the table surface during the procedure.
- ⚠ **WARNING, POTENTIAL FOR INJURY.** To reduce the risk of a potential fall, do not use the product to transport patient between rooms or over thresholds.

STEP	ACTION
1	To lock the caster, step down on the outermost edge of the locking tab located at the top of the caster wheel. (See Figure 4)
2	To unlock the caster step down on the top, innermost edge of the locking tab OR lift up on the outermost edge of the tab. (See Figure 5)

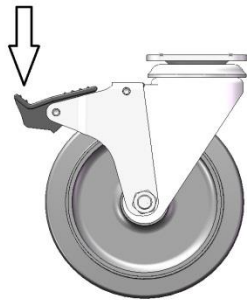

Figure 4

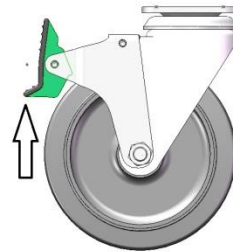

Figure 5

Single Pedal Brake (optional)

The casters installed on your UltraScan™ Table with the optional Single Pedal Brake are total locking casters when in the locked position; the caster is prevented from both rolling and swiveling. When in the neutral position, all casters are free to roll and swivel. The last position is the steer position; with the casters at the head end free to swivel and roll while the casters at the foot end are free to roll but locked from swiveling.

⚠ WARNING, POTENTIAL FOR INJURY OR DEATH. To reduce the risk of a potential fall, lock all casters before using equipment.

⚠ WARNING, POTENTIAL FOR INJURY OR DEATH. Once the table and patient have been properly positioned, ensure the casters are locked and the Hand Wand is placed in a safe position to prevent incidental contact and unwanted movement of the table surface during the procedure.

STEP	ACTION
1	To lock the casters, step down on pedal labeled lock on either side of the table. (See Figure 6)
2	To unlock the casters and obtain the neutral position, step down on the raised pedal on either side of the table until the pedals are level.
3	To utilize the steer function, step down on the pedal labeled steer on either side of the table.

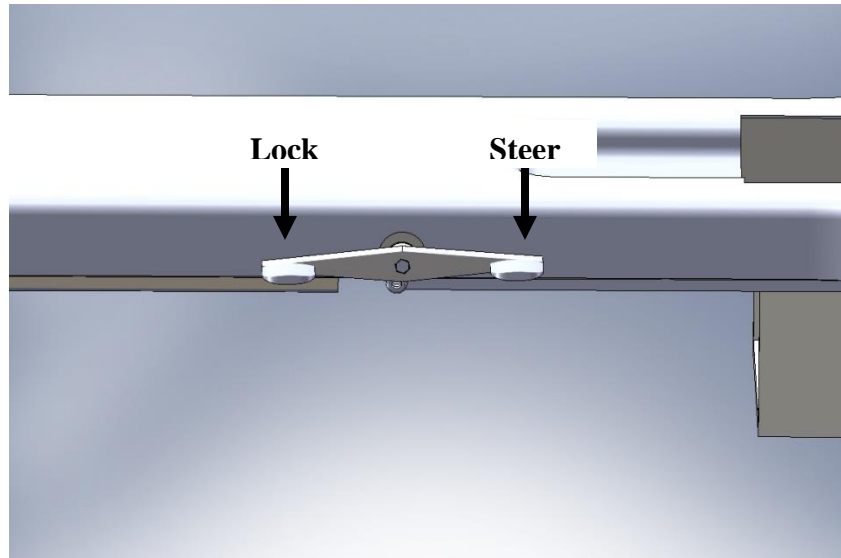

Figure 6

Drop Sections (on select models)

The drop section is designed to be opened or closed easily with one hand.

- ⚠ **WARNING, POTENTIAL FOR INJURY. Avoid placing your hand in or near the drop section mechanism during operation**
- ⚠ **WARNING, POTENTIAL FOR INJURY OR DEATH. After closing, always lift up on the drop section to assure that it is totally locked before patient entry or exit.**

STEP	ACTION
1	To open the drop section, locate the metal handle mounted on the bottom of the drop section at the front edge. (See Figure 7)
2	Pulling the handle outward, from under the drop section, will release the latch mechanism and allow the drop section to swing open. Do not abruptly yank or jerk on handle, it is designed to work with a smooth, steady pull
3	To close the drop section lift the drop section smoothly until it is securely in the full, upright and locked position.

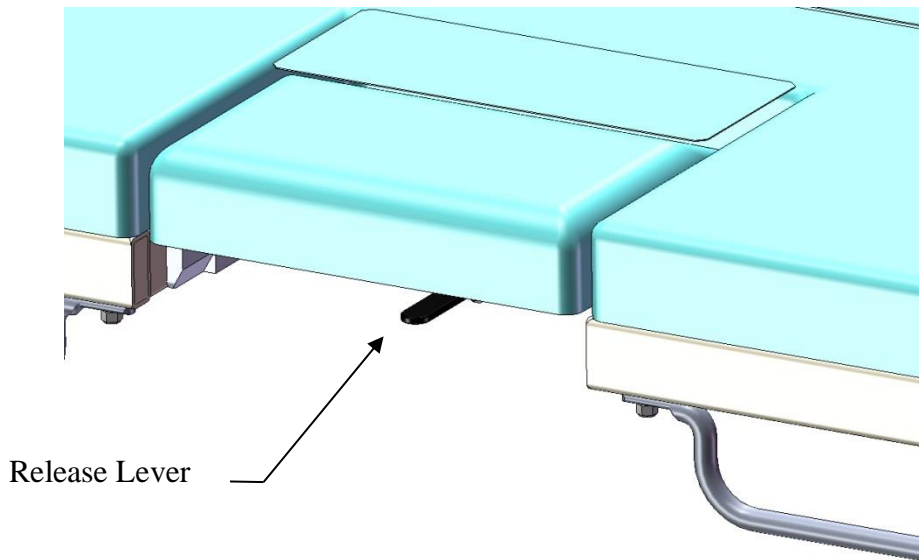

Figure 7

Additionally, the drop section on the patient's left (imagining drop section) can be opened remotely from the left side of the table.

STEP	ACTION
1	To open the imaging drop section remotely, locate the remote release on the patient's right side just next to the left side drop section on the side toward the head of the table. (See Figure 8)
2	Pulling the handle outward will release the latch mechanism and allow the drop section to swing open.
3	To close the drop section lift the drop section smoothly until it is securely in the full, upright and locked position.

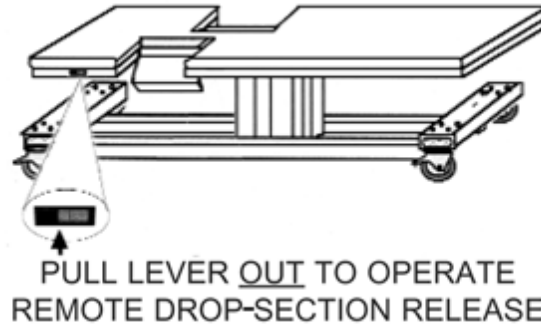

Figure 8

⚠ CAUTION, PRODUCT DAMAGE MAY RESULT. It is not necessary to "slam" the drop section closed. Slamming the drop section closed will startle the patient and may result in damage to the mechanism.

Back Rest (on select models)

Select models of the UltraScan™ Table that have drop sections also has a convenient patient support back rest on the patient’s right side. The back rest is part of a multi-functional feature that also operates as a drop section.

⚠ WARNING, POTENTIAL FOR INJURY. Failure to hold the back rest when the lever release lever will result in the back rest lowering suddenly, possibly causing injury to the patient.

STEP	ACTION
1	To raise, lift up on the outside edge of the back rest (drop section on the patient right) until the locking pin engages and holds the back rest in the elevated position.
2	To lower, grasp the top edge of the back rest and exert a little pressure towards the center of the table and pulling the drop section release handle (See Figure 7) will release the latch mechanism Lower the back rest to the flat position.

Non-Pinch Closure (on select models)

The non-pinch closure flap located at the back edge of the back rest is designed to reduce the possibility of the patient being pinched when the back rest is raised or lowered.

⚠ **WARNING, POTENTIAL FOR INJURY. Do not operate drop section or back rest if non-pinch closure flap is absent. The flap is attached to the bed with hook and loop tape and can easily be adjusted whenever necessary.**

Examine the non-pinch closure flap with the back rest raised and lowered and when the arm rest is open and closed. The flap attaches to the bed surface with hook and loop tape that has been permanently attached to the surface. (See Figure 9)



Figure 9

Occasionally the flap may become bent or creased. When that occurs, remove the flap from the bed surface by separating the hook and loop strips. (See Figure 6) Next, return the flap back to original shape by bending it farther in the opposite direction of the bend or crease and allowing it to spring back to flat.

Should the flap require replacement, you may order one through Medical Positioning, Inc. at 1-800-593-ECHO (3246).

Manually Operated/Removable Foot-Drop Section

The UltraScan™ is provided with a foot drop section that is designed to comfortably and safely support the patient’s legs at times when the foot stirrups are not used. The Ultra DBI™ is provided with a retractable Patient Foot Rest to assist the patient in resting their feet when in the upright, seated position. The patient’s feet should be placed on the metal strip on the front of the Foot Rest.

- ⚠ **WARNING, POTENTIAL FOR INJURY OR DEATH.** The foot drop section is designed to support more weight than a patient’s legs alone, but it is a collapsible and/or removable section and is not designed to support full patient body weight. Never allow the patient to apply full body weight to the extended foot drop section portion of the table while entering or exiting the table as this may result in instability of the table. Have the patient enter and exit the table from the side or from the foot end with the foot section collapsed.
- ⚠ **WARNING, POTENTIAL FOR INJURY OR DEATH.** Verify both sides of the foot drop section’s hinges have the pivot locks engaged when raising the foot section. Failure to have both pivot locks engaged can result in sudden lowering of the foot drop section.
- ⚠ **WARNING, POTENTIAL FOR INJURY.** Keep hands clear of the foot section hinges during operation.
- ⚠ **WARNING POTENTIAL FOR INJURY.** Periodically check both sides of the foot drop section’s hinges to make sure they are between the receivers mounted on both sides of the table’s frame.

Foot Drop Section Operation

STEP	ACTION
1	To lower the foot drop section, slightly lift the foot end of the foot drop section and pull back approximately 1 inch. Carefully lower the foot drop section until it is in a vertical position.
2	To raise the food drop section, grasp the foot drop section near the bottom and swing it up to ta position slightly above horizontal. While in this position, push the foot drop section in to engage the pivot locks.

⚠ WARNING, POTENTIAL FOR INJURY. Use care to firmly hold the removed foot drop section. Failure to hold the foot drop section could result in dropping the foot drop section.

Foot Drop Section Removal/Installation

STEP	ACTION
1	Begin by placing the foot drop section in the lowered position. Grasp the foot drop section on the sides and lift straight up. Use caution to not drop the foot drop section when removing from the table.
2	Grasp the foot drop section on the sides and hold it vertical with the pivot brackets pointing up. While in this position, carefully place the foot drop section's pivot brackets between the receivers mounted to the sides of the table frame and allow the foot drop section to hang in a vertical position. Raise the foot drop section following the raising instructions above.

Foot Board (on select models)

The UltraScan™ is equipped with a foot board that can be opened for use in extreme reverse Trendelenburg (foot end down) positions and when the foot drop section is lowered as a foot rest.

⚠ WARNING, POTENTIAL FOR INJURY OR DEATH. Always raise the foot board when in reverse Trendelenburg (foot end down) positions greater than 15°. Failure to raise the foot board may result in the patient sliding off the table surface.

⚠ WARNING, POTENTIAL FOR INJURY OR DEATH. The foot board is designed to support more weight than a patient's legs alone, but it is a collapsible a section and is not designed to support full patient body weight. Never allow the patient to apply full body weight to the extended foot board while entering or exiting the table as this may result in instability of the table. Have the patient enter and exit the table from the side or from the foot end with the foot section collapsed.

⚠ WARNING, POTENTIAL FOR INJURY. Keep hands clear of the foot board hinges during operation.

⚠ WARNING, POTENTIAL FOR INJURY. The foot board is collapsible and thus care should be taken when lowering the foot board to avoid closing on the patient's feet and/or legs.

STEP	ACTION
1	To raise the foot board, grasp the end toward the head of the table and rotate up and toward the foot of the table.
2	To lower the foot board, grasp the end and rotate down and toward the head of the table.

Foot Stirrups

The foot stirrups are conveniently stored on the underside of the seat section of the UltraScan™ when not in use. When needed, they are horizontally adjustable and will lock in place anywhere along the travel of the support pars.

⚠ WARNING, POTENTIAL FOR INJURY OR DEATH. The foot stirrup is designed to support more weight than a patient’s legs alone, yet is not designed to support full patient body weight. Never allow the patient to apply full body weight to the foot stirrup.

Foot Stirrup Operation

STEP	ACTION
1	To extend the foot stirrups from the storage position, grasp the end, push down and pull out toward the foot end of the table. Rotate the stirrup
2	Rotate the stirrup to the upright position.
3	Repeat the steps 1 and 2 for the other side.
4	The foot stirrups can adjust laterally and in length as desired. The assembly uses a frictional lock to hold in place once weight is applied by placing the patient’s foot in the stirrup.

Foot Stirrup Storage

STEP	ACTION
1	Rotate the stirrup toward the head end of the table and into the storage position.
2	Grasping the end of the foot stirrup, slide the assembly under the seat section of the table by pushing it toward the head end of the table.

Removable Collection Tray (on select models)

The removable collection tray is included on UltraScan™ Tables equipped with the posterior cut-out. The tray is easily removable and replaced when the foot drop section has been removed from the table. The tray may be cleaned according to your institutional policies.

Accessories

Functionality in this section

- Safety Rails
- Sonographer's Extension
- Padded Arm Board
- Carotid Head Rest
- IV Pole Holder
- Patient Positioning Safe-T-Wedges™

Safety Rails

The UltraScan™ can be equipped with optional safety rails. The safety rails lock in the raised position and removable without the use of tools.

⚠ WARNING, POTENTIAL FOR INJURY OR DEATH. Always verify the safety rail is securely latched in the up position before using the table with the safety rail raised. Failure to have the safety rail latched in the raised position may result in a patient fall.

Safety Rail Deployment

STEP	ACTION
1	From the safety rail's stored position, grab the center of the top section of the rail and pull upward until the locking mechanism engages and the safety rail is secure in the up position. (See Figure 10)

Safety Rail Storage

STEP	ACTION
1	To lower the safety rail, lift slightly on the center of the top section of the rail, pull out on rail release knob and lower the rail downward. (See Figure 10)

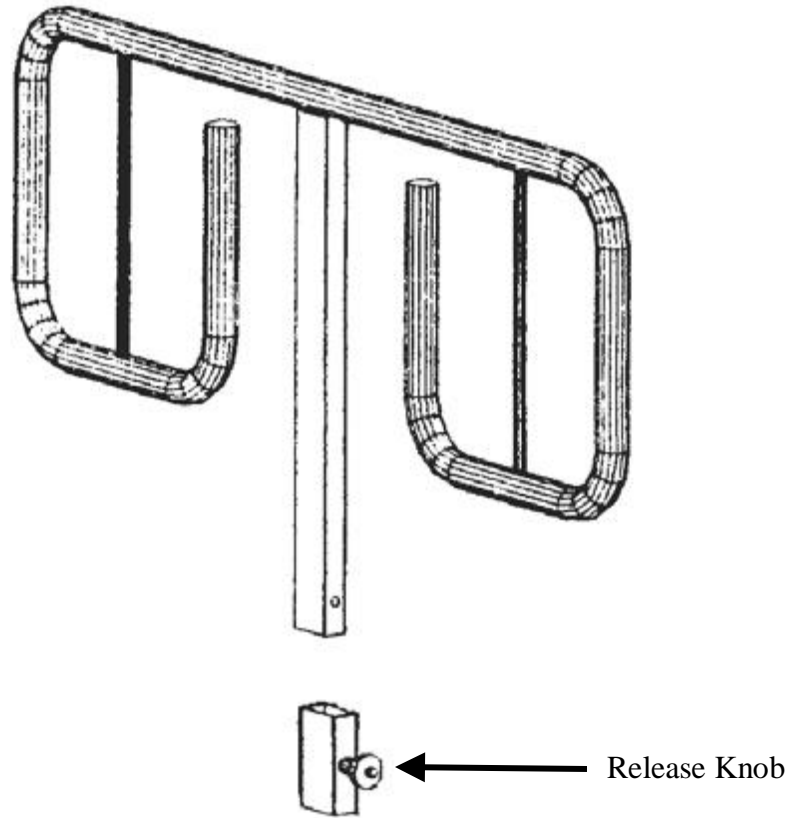

Figure 10

Safety Rail Removal

STEP	ACTION
1	Grab the center of the top section of the rail and pull upward while pulling the safety rail release knob until the safety rail has cleared the release knob. (See Figure 10)

Safety Rail Insertion

STEP	ACTION
1	To insert the safety rail, pull out on rail release knob while inserting the safety rail and lowering it downward. (See Figure 10)

Sonographer's Extension

The UltraScan™ can be equipped with an optional sonographer's extension. The sonographer's extension is designed to increase the usable sitting area and comfort for the sonographer for a right handed scanning sonographer. The sonographer's extension is removable.

Sonographer's Extension Insertion

STEP	ACTION
1	Rotate the support bracket to the side of the use position (See Figure 11)
2	Insert the sonographer's extension pilot tube into the support bracket (See Figure 11)

Sonographer's Extension Removal

STEP	ACTION
1	Pull straight up on the sonographer's extension until the pilot tube is free of the support bracket. (See Figure 11)
2	Rotate the support bracket to the transport position. (See Figure 11)

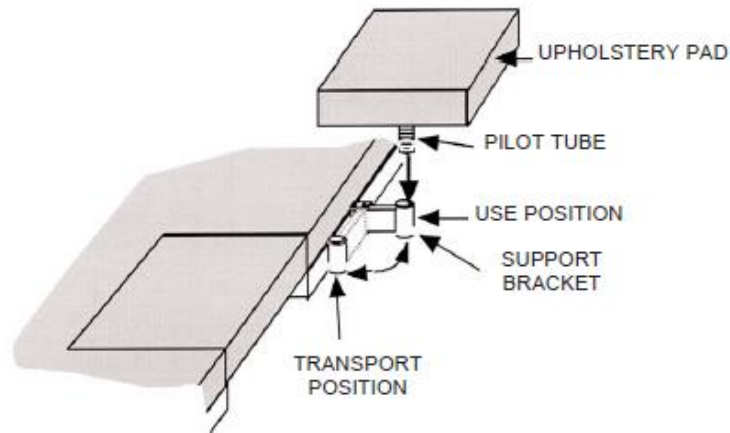

Figure 11

Padded Arm Board

The UltraScan™ can be equipped with an optional padded arm board.

⚠ WARNING, POTENTIAL FOR INJURY. Securely tighten the Hand Wheel for the padded arm board prior to performing any procedures utilizing the padded arm board.

STEP	ACTION
1	Loosen the hand wheel (See Figure 12) by rotating it counter-clock wise.
2	Insert the arm board support tube into the arm board receiver as shown (See Figure 12) and secure the arm board by rotating the hand wheel clock-wise)
3	The angle of the arm board can be adjusted by loosening the hand wheel and rotating the arm board.

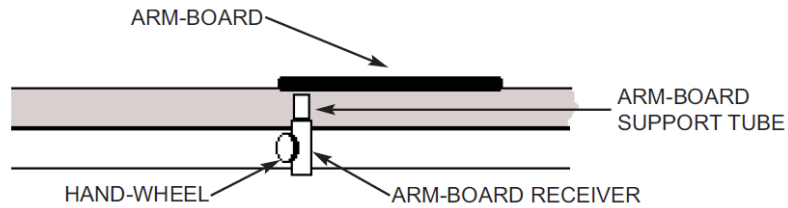

Figure 12

Carotid Head Rest

The UltraScan™ can be equipped with an optional carotid head rest.

⚠ WARNING, POTENTIAL FOR INJURY. Securely tighten the adjustment knobs for the carotid head rest prior to performing any procedures utilizing the carotid head rest.

STEP	ACTION
1	Loosen the horizontal adjusting knob (See Figure 13)
2	Insert the horizontal support tube into the mounting bracket as shown (See Figure 13) and secure the headrest in place by rotating the horizontal adjustment knob in a clock-wise direction.
3	Vertical adjustment of the headrest can be achieved by loosening the vertical adjusting knob and lifting the headrest to the desired height (See Figure 13)
4	The angle of the headrest can be adjusted by rotating it at the point it is joined to the vertical support tube. The tension of the swivel mechanism can be adjusted by tightening or loosening the three (3) tension adjusting bolts (See Figure 13). A 4mm Allen Wrench is required.

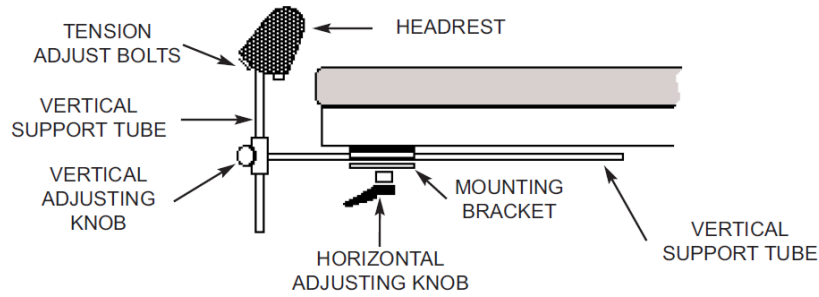

Figure 13

IV Pole Holder

The UltraScan™ may be equipped with an optional IV pole holder for ½ inch diameter IV poles. The IV pole holder is located near the head end of the table. (See Figure 14)

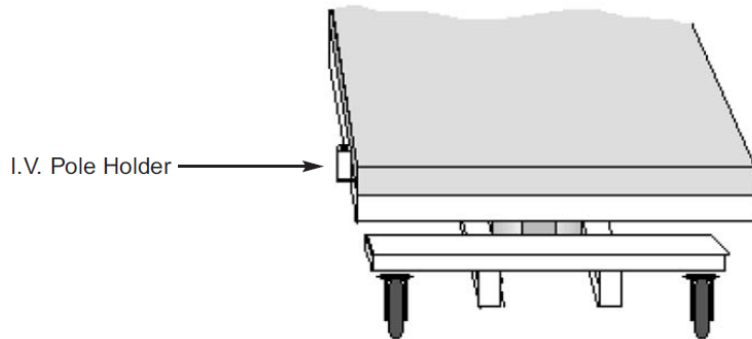

Figure 14

Patient Positioning Safe-T-Wedges™

The UltraScan™ may be used with an optional Safe T Wedge™. The Safe-T-Wedge™ can be used to achieve additional patient positions.

Preventative Maintenance

⚠ WARNING, POTENTIAL FOR INJURY OR DEATH. Do not modify this equipment without authorization of the manufacturer.

The following Preventative Maintenance should be performed at a minimum annually:

- Visually inspect all mechanical assemblies and moving parts on the product ensuring smooth, steady operation
- Visually inspect all fasteners (bolts, nuts, screws, etc.) to insure all are fully installed. Tighten as necessary.
- Visually inspect all electrical cables and wires for signs of abrasion or other damage. If damaged, replace.
- Visually inspect all electrical connections to insure they are fully and properly connected. Reconnect as necessary.
- Visually inspect the hand wand. If damaged, replace.
- Operate all drop section latch mechanisms to insure proper engagement of latch into receiver. Adjust if necessary.
- Operate the back rest latch mechanisms to insure proper engagement and release. Adjust if necessary.
- Operate all motors to insure full extension, retraction and correct operation. The motors are permanently lubricated and require no lubrication.
- Operate the braking system to insure proper engagement of the wheel and swivel lock mechanism. Replace as necessary.
- Operate all accessories to insure proper attachment and operation. Tighten, adjust or replace if necessary



This device contains materials that are potentially hazardous to the environment. In accordance with the DIRECTIVE 2002/96/EC OF THE EUROPEAN PARLIAMENT AND OF THE CONCIL on waste electrical and electronic equipment (WEEE), the Ultra DBI™ electrical system and accessories should not be disposed as unsorted municipal waste. Consult your instructional policies and local regulations regarding disposal. Contact your Medical Positioning, Inc. Service Representative if additional disposal details are required.

Cleaning

NOTE: Substances such as imaging gels and alcohol will not damage the vinyl surface when immediately removed. Studies have shown that exposure for longer than a few minutes can damage the top coat and will eventually discolor vinyl.

NOTE: Always read manufactures instructions and warnings before using any cleaning product or disinfectant.

The painted metal and plastic surfaces can be cleaned with normal cleaners and disinfectant.

STEP	ACTION
1	Clean and/or disinfect with liquid cleaner of choice being careful to follow label instructions provided with cleaner. (Always test a small area first to determine suitability of solution)
2	Wipe the surface clean with a wet cloth after applying cleaners and disinfectant to remove excess residue buildup.

The vinyl upholstered surfaces can be cleaned in one of the following ways:

NOTE: It is recommended that the product be cleaned between patients; please follow your facilities documented policy.

STEP	ACTION
1	When caught quickly, most everyday stains like grease, blood and black felt tip pens can be wiped right off. Use mild soap and water. For more stubborn stains, a variety of concentrated and solvent type cleansers may be used without damaging the surface (including alcohol, naphtha and bleach), as long as they are thoroughly rinsed off with water. Abrasive household cleaners and steel wool should never be used.
2	Everyday soil can usually be removed using a soft cloth or sponge with mild soap and water. Spills and accidents require immediate attention for best results. In many cases, stains may be cleaned simply with warm water alone. If the stain is allowed to set, more concentrated cleaners may be required.

The following guide covers many of the most common staining agents. During independent laboratory testing, many were allowed to stand for up to 40 hours with excellent cleaning results.

Generally speaking, always start with the mildest cleaning agents first. Never use harsh powdered abrasive cleansers or steel wool. Products containing bleach, ammonia or alcohol (Lysol™) should be wiped from the surface with a wet cloth after use. Residue from these products will damage vinyl surfaces

UltraScan™ Table

STEP	ACTION
1	Remove excess spill with damp cloth. Clean with 1:1 mix of Ivory™ soap and water. Rinse with clean water and dry.
2	Use straight application of concentrated cleaners such as Formula 409™ or Fantastik™ Spray Cleaner. Then wipe with clean cloth.
3	Use a 1:1 mix of ammonia and water or a 1:4 mix of bleach and water. Rinse with clean water and dry.
4	Use straight application of naphtha (lighter fluid). Rinse thoroughly with clean water and pat surface dry. (see note below)
5	Use 1:1 mix of isopropyl alcohol and water. If stain persists, use straight alcohol. Rinse thoroughly with clean water pat surface dry. If stains remain, use a 1:1 mix of acetone and water. Rinse with clean water and pat surface dry. (see note below)

Note: For cleaning that requires steps 4 or 5 - use a soft cotton cloth saturated with the cleaning material, rub the stain in circles 10 times. Pat area dry with another soft cotton cloth and check results.

This information is not a guarantee and does not relieve the user from the responsibility of the proper and safe use of the product and all cleaning agents.

- Formula 409™ is a trademark of the Clorox Company.
- Fantastik™ Spray Cleaner is a trademark of the Texize Division of Dow consumer Products, Inc.
- Ivory™ is a trademark of Procter and Gamble
- Lysol™ is a trademark of Reckitt & Colman Inc.

Troubleshooting Guide

A “**Troubleshooting Guide**” is included to instruct you in the event of a malfunction. If you are experiencing any of the following symptoms, this guide may help you quickly solve the problem. If, after consulting this guide, you are still unable to operate your table please contact Medical Positioning at 1-800-593-3246. Please have the following information ready when you call:

1. Model Number or Name of Product
2. Date Received
3. Condition When Received
4. Symptom (or problem) Encountered & Result of Troubleshooting Procedure

Complaint Reporting Procedure

In the event of a product malfunction or patient injury, please immediately report the incident to:

1. _____
(The distributor from whom the product was purchased)
2. Medical Positioning, Inc
1717 Washington Street
Kansas City, MO 64116
www.MedicalPositioning, Inc.
011-816-474-1555
800-593-3246 (ECHO)

SYMPTOM	PROBABLE CAUSE	SUGGESTION
No Actuator Function Actuator(s) Not Running	<ul style="list-style-type: none"> • Power cord not plugged all the way into wall receptacle 	<ul style="list-style-type: none"> • Push power cord securely into receptacle.
	<ul style="list-style-type: none"> • Power outlet receptacle not supplying power 	<ul style="list-style-type: none"> • Check power availability or plug unit into another receptacle
	<ul style="list-style-type: none"> • The power cord may be separated from the control box 	<ul style="list-style-type: none"> • Securely press power cord into control box (Figure 16)
	<ul style="list-style-type: none"> • Hand wand not properly connected to control box 	<ul style="list-style-type: none"> • Securely press end of hand-wand into control box(Figure 15 and 16)
	<ul style="list-style-type: none"> • Actuator power cord not fully connected to control box 	<ul style="list-style-type: none"> • Securely press end of actuator power cord into control box (Figure 16)

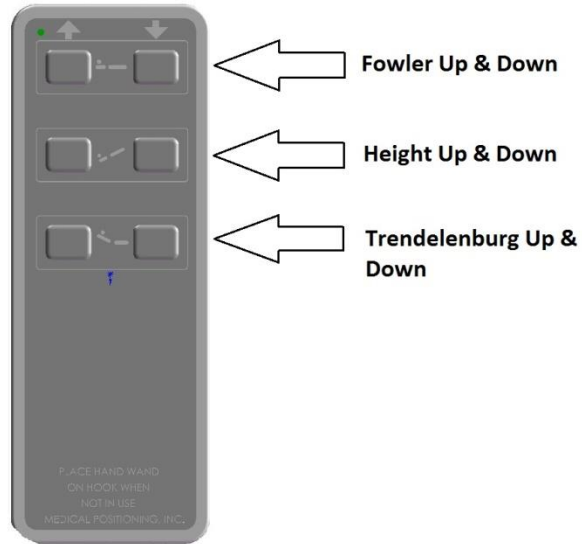

Figure 15

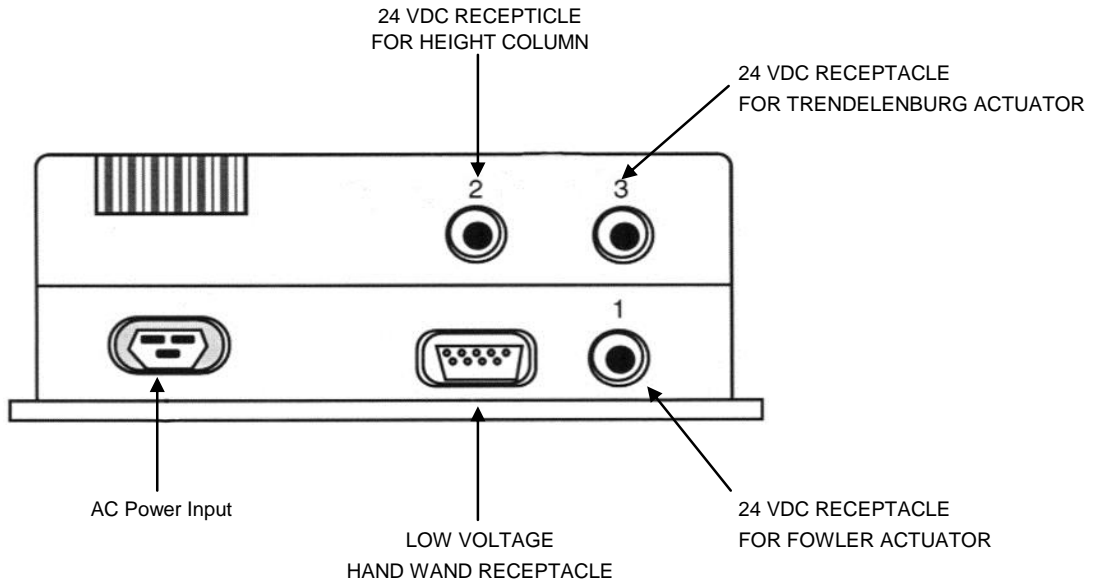

Figure 16

UltraScan™ Table Parts List

Part Number	Description
10220	SHAFT, TRENDELENBURG
10350	LATCH, COMPARTMENT LOCK, REVERSIBLE, ZN
10351	HANDLE, DROP SECTION
10373	FOW-3 COLUMN BRACKET
10454	FOW-6 HINGE PIN
10582	LEVER, MINI W/CABLE #FA3421000
10598	HINGE, DROP SECTION
10691	BRKT, 500 SER. DUAL DS REL. LEVER
10710	COVER, LATCH, TABLES
10728	KOM33-20A-000 US/JP
10770	BAR, STOP, TABLE
10956	FOW-61, UPPER DUAL FRAME
10969	BEARING, FLANGE, 7/8 ID X 1 1/8 OD X 1 L X 1 3/8 FOD, .155 FT, SAE 841
10977	ACTUATOR, MAX30-A080295A1710A-
11005	VT-1 UPPER SECTION
11049	ACTUATOR, TLG10-ADXXA-022
11397	UPHOLSTERY KIT, ULTRASCAN
11398	UPHOLSTERY KIT, ULTRASCAN DUAL
11481	COVER, D.S. LATCH HANDLE#.125-
11751	PAN, #NOR3849
11802	UST-53 FOOT DROP MANUAL
11842	UT-2 FOOT DROP SECTION
11849	TOP FRAME, COLUMN
11918	HANDSWITCH, H-TR-F NO MEMORY
11929	ACTUATOR, MAX30-A200415A1610A-
11956	SCREW, FOW, ADJ
11965	UT-4 MID SECTION W/CUTOUT
11971	UST-4 TR LUG 15/25
11972	UST-6 TR LUG 15/15
11973	UST-13 FOOTBOARDS HINGE BRACKET
11974	UST-14 FOOTBOARD HINGE BRACKET
11975	COVER, FOOTBOARD GAP UT 5
11976	ACTUATOR, MAX30-A110325A25100-
11979	UT-6, FOOT DROP
11980	UT-7 FOOT STATIONARY SECTION
12017	UST-8 STIRRUP BACKSTOP
12018	UST-9, FRONT GUIDE, STIRRUP
12019	UST-16 STIRRUP BAR
12027	UST-22 DS ADAPTER BRACKET
12033	MODIFICATION, STURRUP #UST 21
12172	BASE 4
12173	BRACKET, CONTROL BOX
12270	ZKA-140360-3500, M/0121732 - c
12277	CASTER, 5" EXPANDING STEM, TTL
14210	Shaft, Manual Foot Hinge

UltraScan™ Table

14222	Assembly, Stationary Frame
14668	UPHOLSTERY KIT, ULTRASCAN FC
14669	UPHOLSTERY KIT, ULTRASCAN 25TR-FC
14670	UPHOLSTERY KIT, ULTRASCAN 25TR
14671	UPHOLSTERY KIT, ULTRASCAN DUAL-FC
14672	UPHOLSTERY KIT, ULTRASCAN DUAL-25TR-FC
14673	UPHOLSTERY KIT, ULTRASCAN DUAL-25TR

Specifications and Warranty

Specifications

ATTRIBUTE	SPECIFICATION
Electrically Adjustable Height	25.5" to 34.5"
Electrically Adjustable Fowler Positioning	0° to 90°
Electrically Adjustable Trendelenburg Positioning	
8X87, 8X89	0°
8X91, 8X92, 8X94, 8X95	0° to 15°
Electrically Adjustable Reverse Trendelenburg Positioning	
8X87, 8X89	0°
8X94, 8X95	0° to 15°
8X91, 8X92	0° to 25°
Electrically Isolated Hand Wand	24 VDC
Load Capacity, Table	500 Lbs.
Load Capacity, Padded Arm Boards	33 Lbs.
Load Capacity, Carotid Head Rest	33 Lbs.
Load Capacity, IV Pole Holder	33 Lbs.
Casters	5" Individual Lock Casters or 5" Single Pedal Lock and Steer
Length	72"
Width	28"
Weight	290 Lbs.
Foam	Cal. B.F.T.B. #117
Vinyl	D.O.T. FAR25.8536. M.V.S.302 Port of NY / Boston F.D. Code
Electrical	120 VAC, 50/60 Hz, 2A 230 VAC, 50/60 Hz, 1A

Standard and Optional Configurations

Attribute	Standard												Option	
	8087	8089	8091	8092	8094	8095	8287	8289	8291	8292	8294	8295		
Individual Lock Casters	X	X	X	X	X	X	X	X	X	X	X	X	X	
Single Pedal Brake														X
Drop Sections							X	X	X	X	X	X	X	
Back Rest							X	X	X	X	X	X	X	
Non-Pinch Closures							X	X	X	X	X	X	X	
Manually Operated/Removable Foot-Drop Section	X	X	X	X	X	X	X	X	X	X	X	X	X	
Foot Board			X	X				X	X					
Foot Stirrups	X	X	X	X	X	X	X	X	X	X	X	X	X	
Removable Collection Tray		X	X		X			X	X		X			
Safety Rails														X
Sonographer's Extension														X
Padded Arm Board														X
Carotid Head Rest														X
IV Pole Holder														X
Patient Positioning Safe-T-Wedge™														X

Warranty

Warranty

UltraScan™

1 YEAR WARRANTY

This product is fully guaranteed against defects in material and/or workmanship during the period indicated above, commencing with the manufacturing date. If a product fails due to a manufacturing defect, Medical Positioning, Inc. (MPI) will repair or authorize repairs to the product without charge, or replace the product at MPI's option.

Preventative maintenance and repairs due to accident, improper care, negligence, or other non-defect related failures are not covered by this warranty. This warranty does not apply to products that have been modified without the advance written permission of MPI.

MPI makes no other warranty, either expressed or implied, with respect to this product. MPI specifically disclaims the implied warranties of merchantability and fitness for a particular purpose.

The remedies provided herein are the customer's sole and exclusive remedies. In no event shall MPI be liable for any direct, indirect, special, incidental, or consequential damages, whether based on contract, tort, or any other legal theory.

A 30 day return policy from the date of receipt applies to new products, subject to a restocking fee and quality inspection. The product shall not be returned without prior written authorization from MPI. The customer is responsible for all shipping charges and any applicable duties or taxes.

Medical Positioning, Inc.

1717 Washington St.
Kansas City, Missouri 64108
(816) 474-1555
(800) 593-3246
Fax (816) 474-7755

WAR069-A